



**INSTRUCTIONS D'ASSEMBLAGE**  
**ASSEMBLY INSTRUCTIONS**

---

**M**ONARCH  
SPECIALTIES INC.

# I 7055

---

**CREDESCENCE -**  
**BLANC / 2 TIROIRS A ROULETTES**

**OFFICE CABINET -**  
**WHITE WITH 2 DRAWERS ON CASTORS**



**POUR DE L'ASSISTANCE OU POUR COMMANDER  
DES PIÈCES CONTACTEZ NOTRE DÉPARTEMENT  
DE SERVICE À LA CLIENTÈLE.**

**FOR ASSISTANCE OR TO ORDER PARTS  
CONTACT OUR CUSTOMER SERVICE DEPARTMENT**

**WWW.MONARCHSERVICE.COM**

**LISTE DES PIÈCES**  
**PARTS LIST**

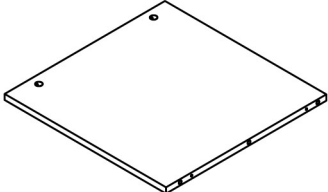
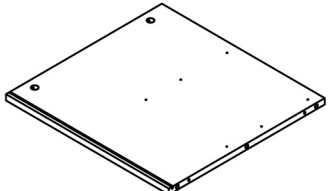
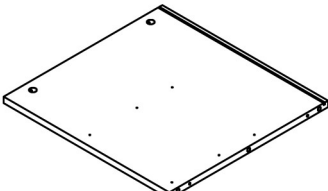
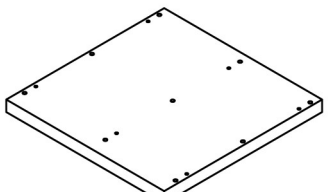
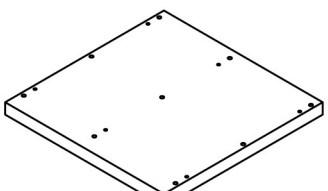
PIÈCE / PART #	IMAGE	DESCRIPTION	QTY / QTÉ
1		FRONT FACING LEFT SIDE PANEL PANNEAU DE CÔTÉ GAUCHE	1
2		FRONT FACING RIGHT SIDE PANEL PANNEAU DE CÔTÉ AVANT DROIT	1
3		DIVIDER PANEL PANNEAU DE DIVISION	1
4		BOTTOM PANEL PANNEAU DU BAS	1
5		TOP PANEL PANNEAU DE SURFACE	1

**LISTE DES PIÈCES**  
**PARTS LIST**

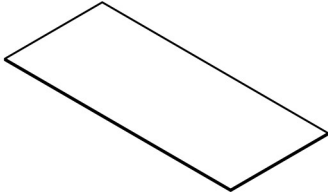
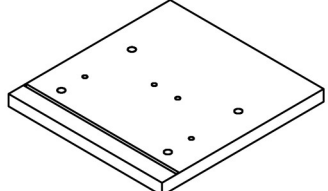
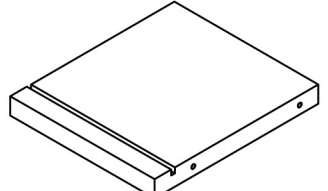
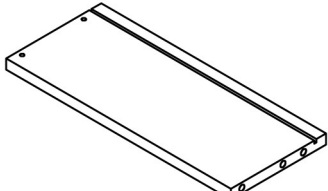
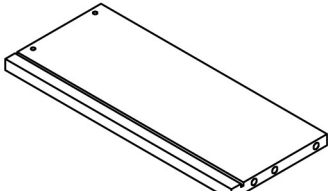
PIÈCE / PART #	IMAGE	DESCRIPTION	QTY / QTÉ
6		BACK PANEL PANNEAU ARRIÈRE	1
7		DRAWER FRONT PANEL PANNEAU AVANT TIROIR	2
8		DRAWER BACK PANEL PANNEAU ARRIÈRE TIROIR	2
9		DRAWER SIDE PANEL PANNEAU DE CÔTÉ TIROIR	2
10		DRAWER SIDE PANEL PANNEAU DE CÔTÉ TIROIR	2

**LISTE DES PIÈCES**  
**PARTS LIST**

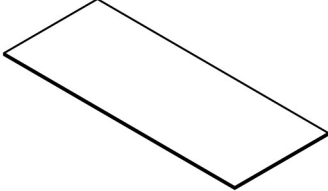
PIÈCE / PART #	IMAGE	DESCRIPTION	QTY / QTÉ
11		DRAWER BOTTOM PANEL PANNEAU DU BAS TIROIR	2

**LISTE DES PIÈCES DE MONTAGE**  
**HARDWARE LIST**

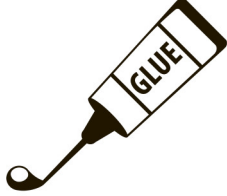
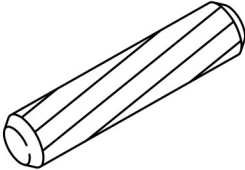
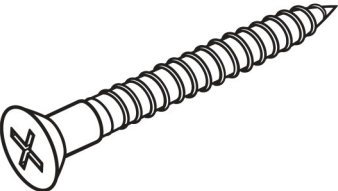
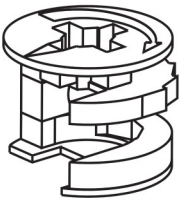
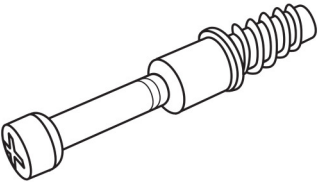
PIÈCE / PART #	IMAGE	DESCRIPTION	QTY / QTÉ
A		GLUE COLLE	1
B		WOOD DOWEL - Ø3/8" X 1 1/8" GOUJON DE BOIS - Ø3/8" X 1 1/8"	26
C		ASSEMBLING SCREW - 1 5/8" VIS D'ASSEMBLAGE - 1 5/8"	6
D		CAM LOCK CONNECTOR - Ø5/8" X 1/2" ÉCROU CAM LOCK - Ø5/8" X 1/2"	10
E		CAM LOCK SCREW - 1 3/8" VIS CAM LOCK - 1 3/8"	10

**LISTE DES PIÈCES DE MONTAGE**  
**HARDWARE LIST**

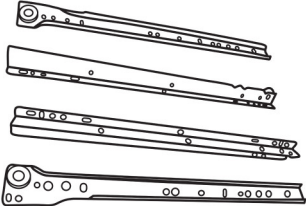
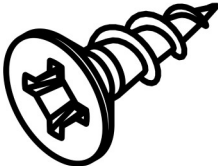
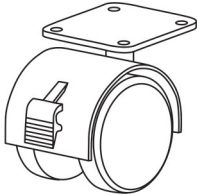
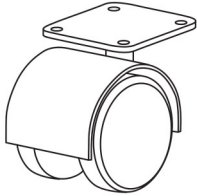
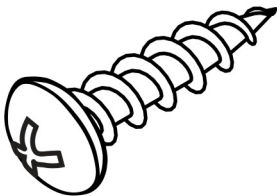
PIÈCE / PART #	IMAGE	DESCRIPTION	QTY / QTÉ
<b>F</b>		<b>METAL DRAWER SLIDE -</b> <b>13 3/4"</b> <b>COULISSE DE MÉTAL -</b> <b>13 3/4"</b>	<b>2</b>
<b>G</b>		<b>ASSEMBLING SCREW -</b> <b>1/2"</b> <b>VIS D'ASSEMBLAGE -</b> <b>1/2"</b>	<b>24</b>
<b>H</b>		<b>WHEEL -</b> <b>Ø2"</b> <b>ROUE -</b> <b>Ø2"</b>	<b>2</b>
<b>I</b>		<b>WHEEL -</b> <b>Ø2"</b> <b>ROUE -</b> <b>Ø2"</b>	<b>2</b>
<b>J</b>		<b>ASSEMBLING SCREW -</b> <b>5/8"</b> <b>VIS D'ASSEMBLAGE -</b> <b>5/8"</b>	<b>16</b>

**LISTE DES PIÈCES DE MONTAGE**  
**HARDWARE LIST**

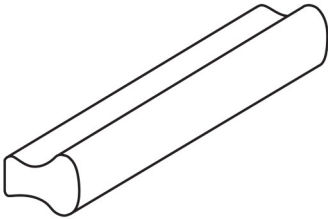
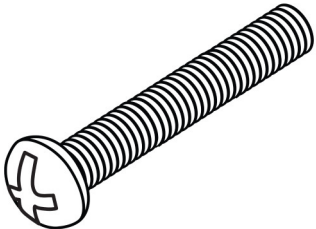
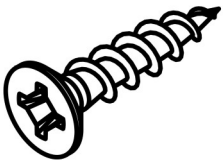
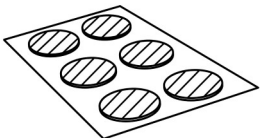
PIÈCE / PART #	IMAGE	DESCRIPTION	QTY / QTÉ
K		HANDLE - 2" POIGNÉE - 2"	2
L		ASSEMBLING BOLT - 7/8" BOULON D'ASSEMBLAGE - 7/8"	4
M		ASSEMBLING SCREW - 1 3/8" VIS D'ASSEMBLAGE - 1 3/8"	8
N		FINISHING STICKER - Ø3/4" COLLANT DE FINITION - Ø3/4"	10

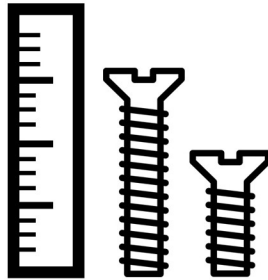

OUTIL DE VÉRIFICATION DE DIMENSIONS DES PIÈCES  
HARDWARE DIMENSIONS VERIFICATION TOOL

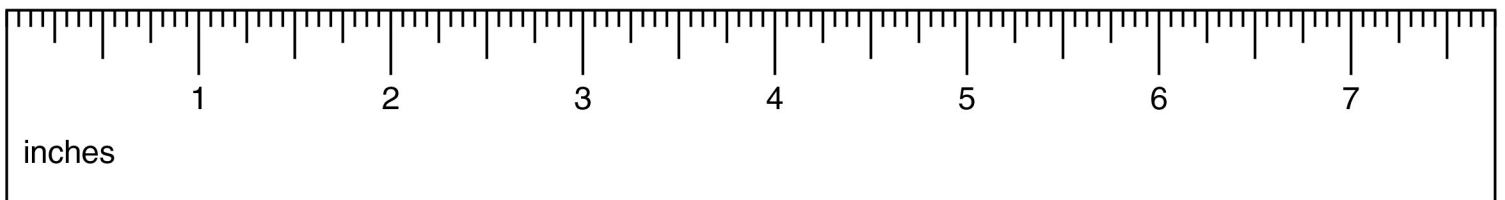



**ÉTAPE / STEP 1**

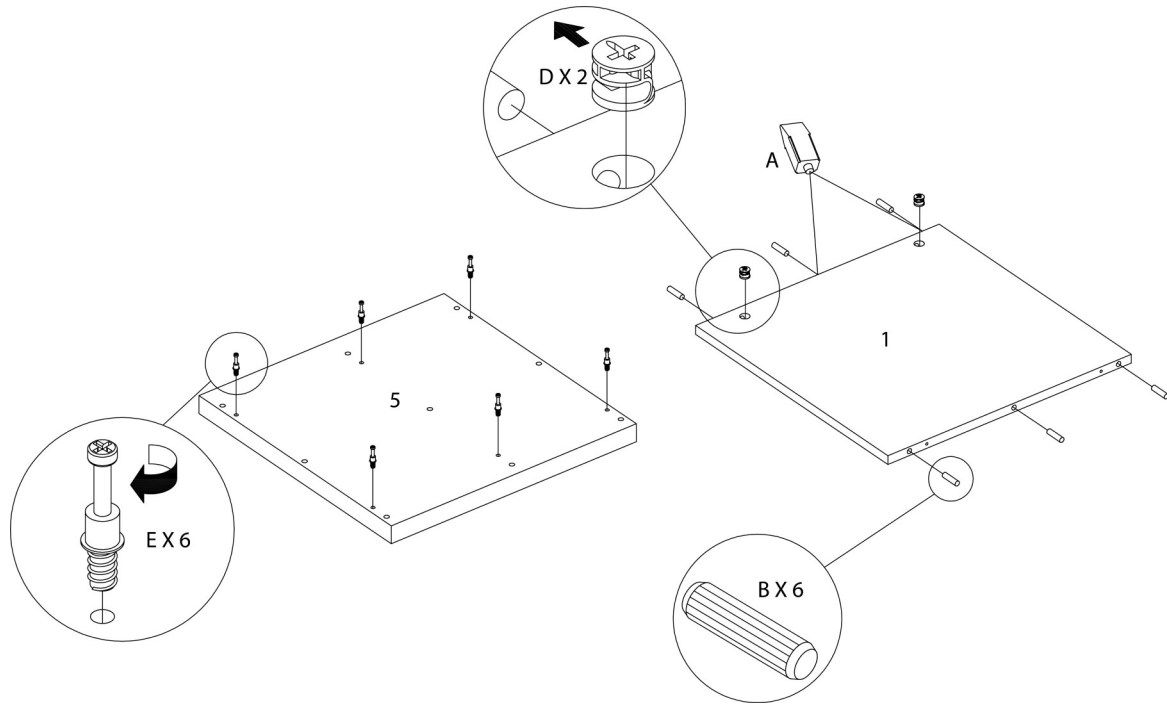

**ÉTAPE / STEP 2**

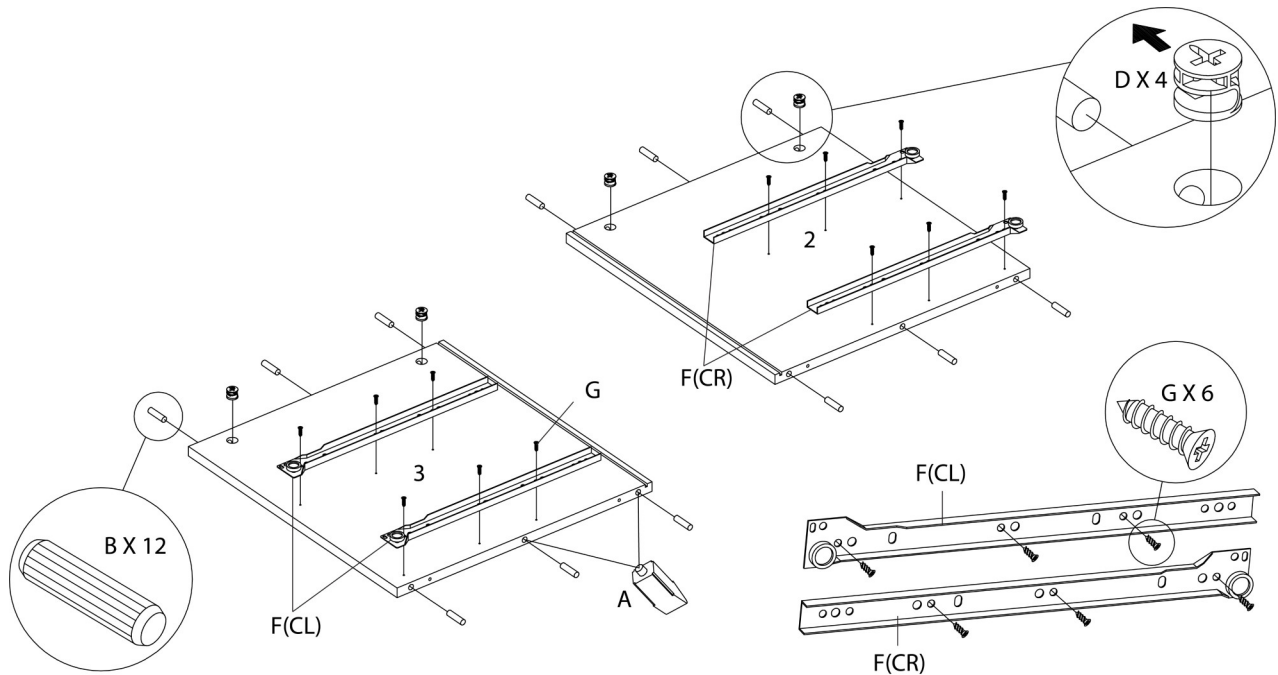

ÉTAPE / STEP 3

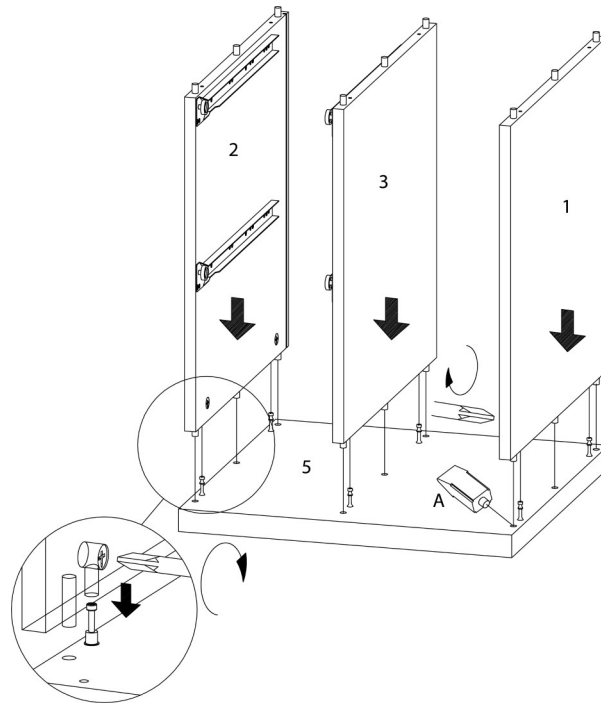

ÉTAPE / STEP 4

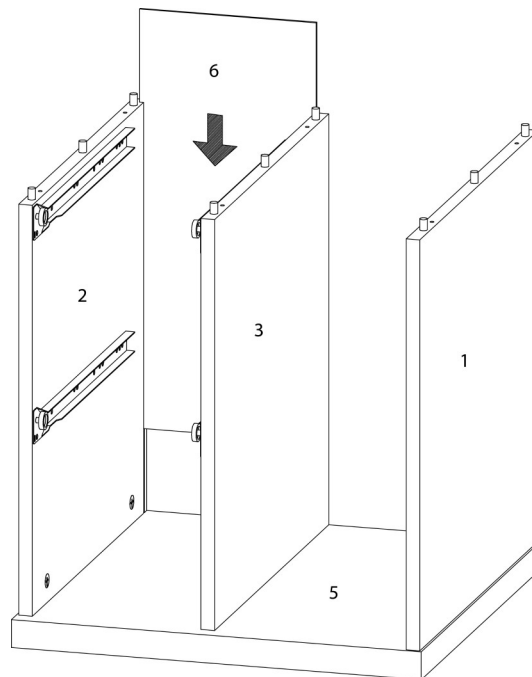

ÉTAPE / STEP 5

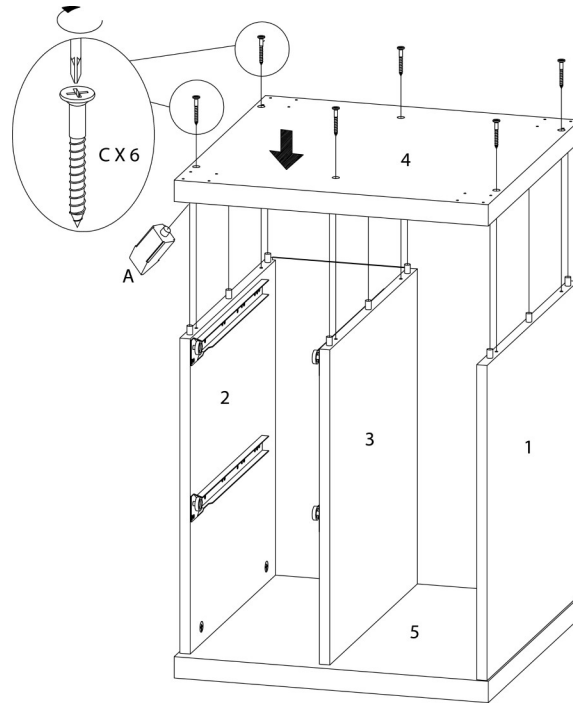

ÉTAPE / STEP 6

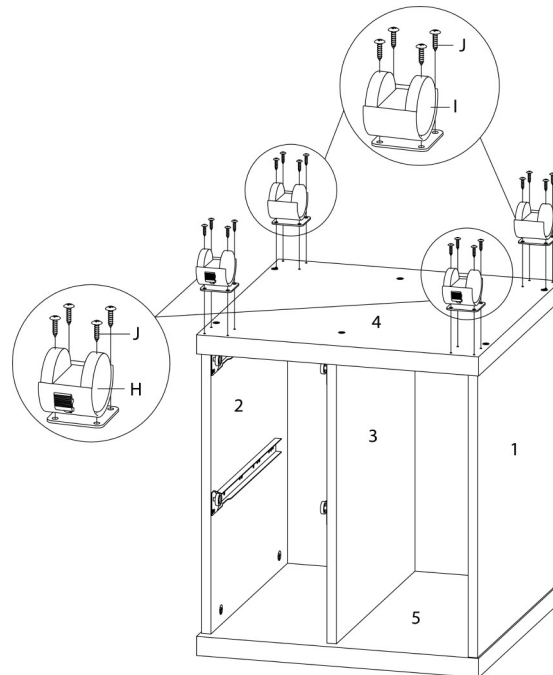

**ÉTAPE / STEP 7**

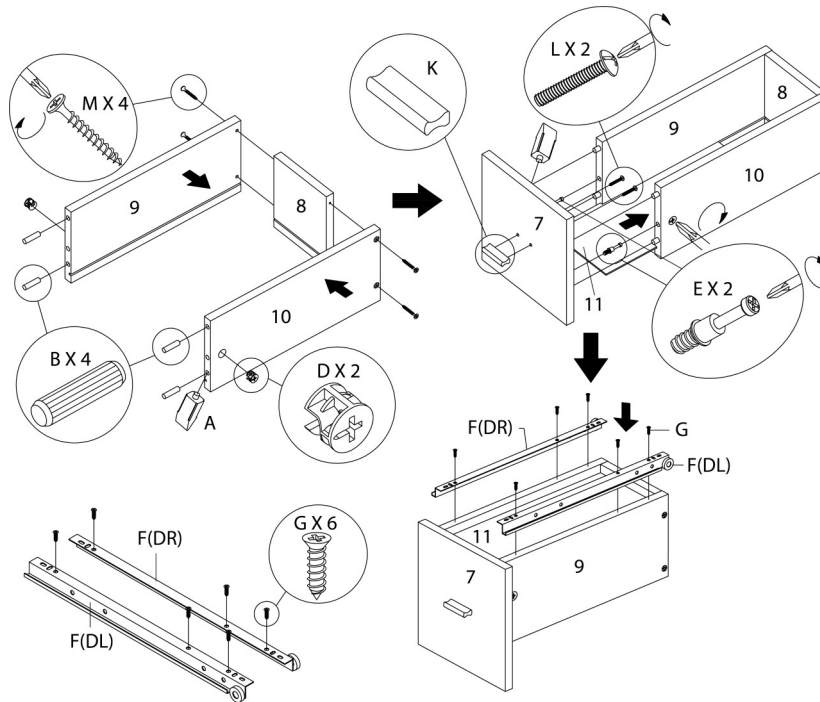

**ÉTAPE / STEP 8**

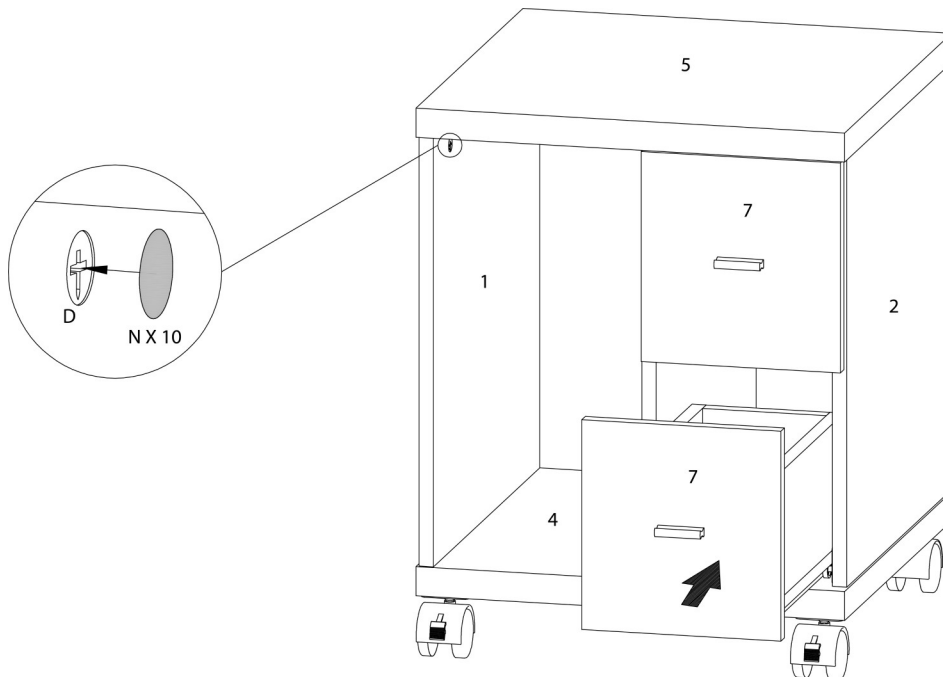

ÉTAPE / STEP 9

